

 Sandberg®

**5**  
Years  
Warranty



**Quick Guide**

134-45

[www.sandberg.world](http://www.sandberg.world)

**USB-C/A Webcam Pro Remote 4K**

## Overview

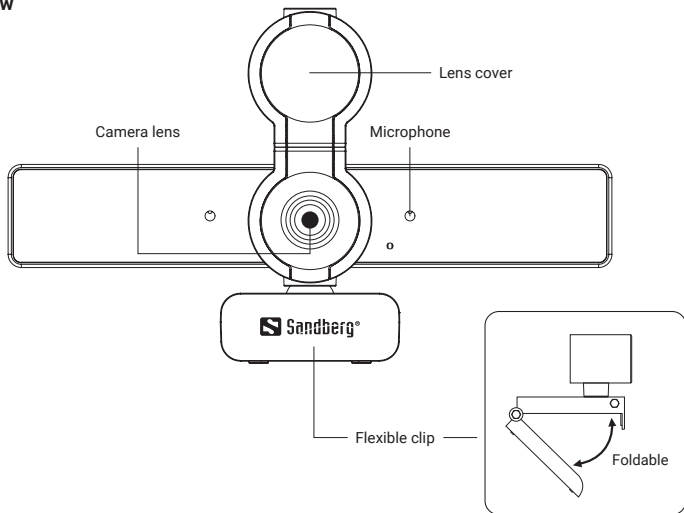

The camera works driver-less and is compatible with most chat-applications.

If you want to get further options for video-effects and image adjustments, please follow this link:  
[www.sandberg.world/webcamguide](http://www.sandberg.world/webcamguide)

### Connection

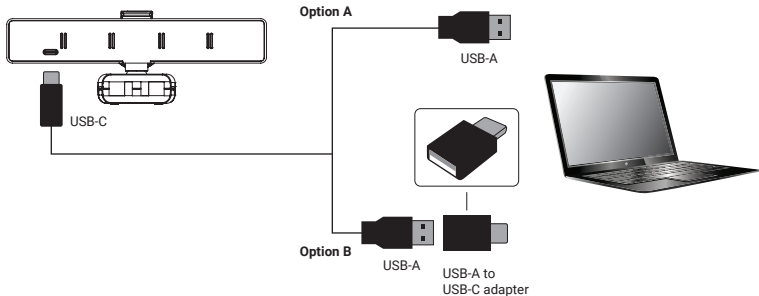

### Example of mounting

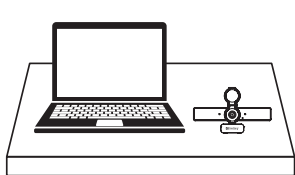

On a Desk

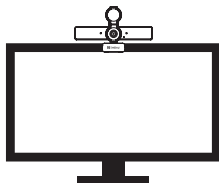

On a PC Monitor



On a tripod, for example Sandberg item no. 134-11

## Insert batteries

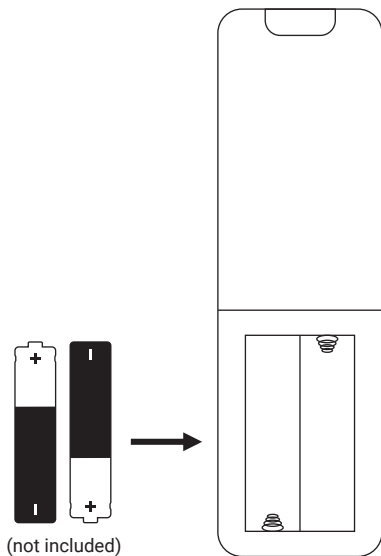

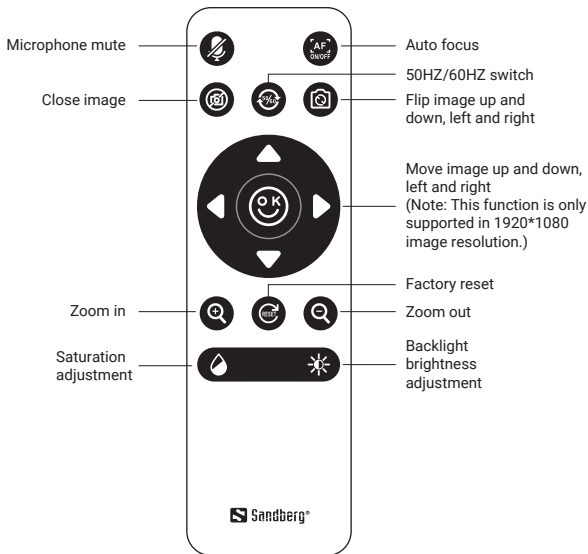
**Remote control**

**NOTE:** Pan and tilt functions are only possible if image is zoomed in.

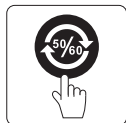

= 50Hz/60Hz AC  
flicker correction  
(50 Hz for Europe)

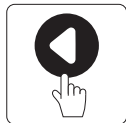

= Factory defaults  
(Reset)



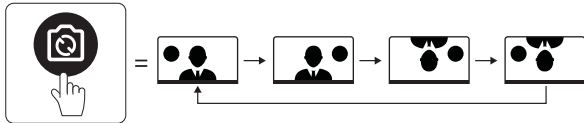
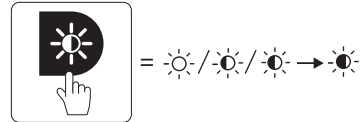
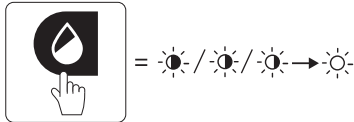
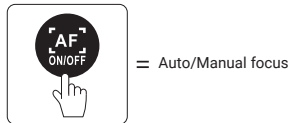
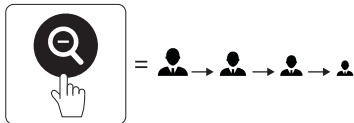

## Support

<http://helpdesk.sandberg.world>

## Warranty

There is a five-year warranty on your Sandberg product. Please read the warranty terms and register your new Sandberg product at [www.sandberg.world/warranty](http://www.sandberg.world/warranty)

**5**  
Years  
Warranty

### USB-C/A Webcam Pro Remote 4K

Item no. 134-45

[www.sandberg.world](http://www.sandberg.world)

[info@sandberg.world](mailto:info@sandberg.world)

Sandberg A/S

Bregnerødvej 133D,

3460 Birkerød, Denmark

Made in China

